

A450C+ is a highly accurate digital two color IR Focusable pyrometer to provide high performance and low maintenance of non contact temperature measurement in demanding industrial and R&D environments. The Pyrometer measures the temperature of an object by calculating the ratio of the energies at two different wavelength bands. The ratio technique eliminates and reduces errors in temperature measurement caused by changes in Emissivity, Surface finish and energy absorbing materials such as Water vapour etc.

The IR pyrometer parameters can be selected via the keypad on the back panel. The settings are displayed on the OLED Display. In the measuring mode, real time temperature is displayed. In Pyrometers with video module, real time colour video, measuring temperature and emissivity is displayed on the television screen. A450C+ has focusable optics for optimal match of the instrument for various applications. The pyrometer is equipped with RS-485 output; analog outputs 0/4...20mA. Switching laser ON/OFF does not effect the measurement.



Software "Infrasoft"

AST "Infrasoft" software is under standard scope of supply. It offers possibilities of connecting three pyrometers simultaneously for parameter setting, view real time graph, offline graph and to evaluate measuring data. Communication between the pyrometer and the software is implemented via a cable connected between the pyrometer and the PC serial port. It comes with record feature, spot size calculator and parameter settings features.

Some of the parameters adjustable via software are

- Emissivity, Response Time
- Clear Time(Peak Picker)
- Analog Output
- Sub Range
- Unit of Temperature(°C/°F)
- Communication mode(Comm.mode)

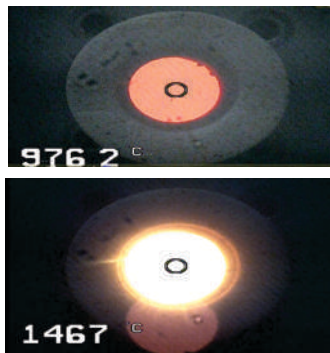

Example Video Image

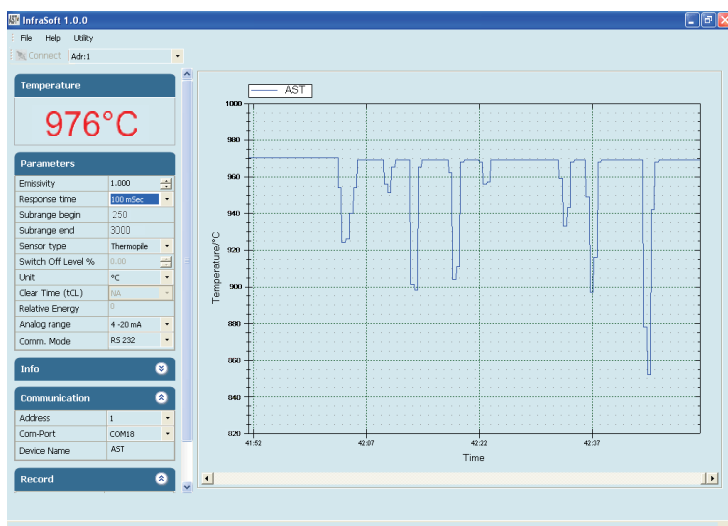

Infrasoft with integrated video image

Features

- Wide temperature ranges from 600°C to 2500°C
- Focusable Optics
- Fast Response Time
- Spectral range 0.7 μm....1.15 μm
- Integrated OLED Display & Parameterizing Keys
- Two Color model (switchable to single colour mode)
- Laser targeting, Through The lens view finder and video sighting options are available
- Analog output options 0...20mA/4...20mA
- RS-485 Serial interface
- User friendly PC software for communication
- Green LED for pyrometer status indication
- Red LED for Laser ON/OFF indication

Standard Scope of Supply

- Pyrometer with Focusable optics, OLED Display & Parameterizing Keys
- Laser pilot light(PL)/Through the lens(TL) sighting / Video (user can select while ordering)
- Analog output 4...20mA, 0...20mA
- Digital Interface RS-485
- 5 mtr long connection cable with connector
- 1.5 mtr. Communication Cable
- Calibration certificate, Software & Operation manual

Optional

- Mechanical & Electrical Accessories
- Extra Cable Lengths

Applications

- Induction Heating
- Annealing
- Welding
- Forging
- Sintering
- Melting
- Rolling Mills
- Rolling Kilns
- Crystal growing

Technical Specifications

Model	A450C+
Temperature Range (Analog sub-range adjustable)	600°C - 1600°C 800°C - 2500°C
Spectral Range	0.7....1.15 µm
Photodetector Type	Si/Si
Distance to Spot Size Ratio	150:1 (600°C - 1600°C) 300:1 (800°C - 2500°C)
Emissivity (ε)	0.1....1.0 adjustable (Single color mode)
Emissivity Slope (ε1 / ε2)	0.75...1.25 slope adjustable (Two color mode)
Response Time	20 msec adjustable upto 10 sec
Accuracy	± 0.5% of the measured value + 1°C
Repeatability	0.1% of reading in °C + 1°C
Sighting Options	Laser Pilot Light(PL), Through The Lens (TL) & Video Module
Analog Output	0-20mA, 4-20mA (User selectable)
Digital Output	RS-485
Operating Temp. Range	0°C.....70°C
Storage Temp. Range	-20°C...70°C
Adjustable Parameters and Features via Software and Android app	Emissivity, Emissivity Slope, Response Time, Clear Time (Peak Picker), Analog Output, Analog Scale (Sub range), Sensor type (Switches b/w 2-color or single color), Switch off level, Unit Of Temperature(°C/°F), Communication mode (Comm.mode), Record feature, Relay set point & hysteresis, etc.
Adjustable Parameters and Features via Keypad	Emissivity, Emissivity Slope, Response Time, Clear Time (Peak Picker), Analog Output, Analog Scale (Sub range),Sensor type (Switches b/w 2-color or single color), Switch off level, Unit Of Temperature(°C/°F), Communication mode (Comm. mode), Relay set point & hysteresis, address, etc.
Relay output	One Relay output with hysteresis 60V DC / 42 AC RMS, 0.4 A
Power Supply	12V to 28V DC with reverse voltage protection
Power Consumption	Max 4.0 watt
Laser Power	<1 m watt (only PL model)
Protection Class	IP65
Housing	Stainless Steel
Isolation	Power supply,Digital output and Analog output are galvanically isolated against each other
Operating Humidity	10-95%, Non-Condensing Conditions
Weight & Dimensions	1200g Dia= Ø 56mm; Length=199.5mm

Spot Sizes

Focused Working Distances (mm)	Spot Sizes (mm)	
	A450C+ 600- 1600°C (150:1)	A450C+ 800- 2500°C (300:1)
500	3.30	1.65
1000	6.65	3.35
2000	13.40	6.70
4000	26.70	13.40
9000	60.0	30.0

We measure accurate temperature in extreme conditions

Pyrometer & Cooling Jacket Drawing

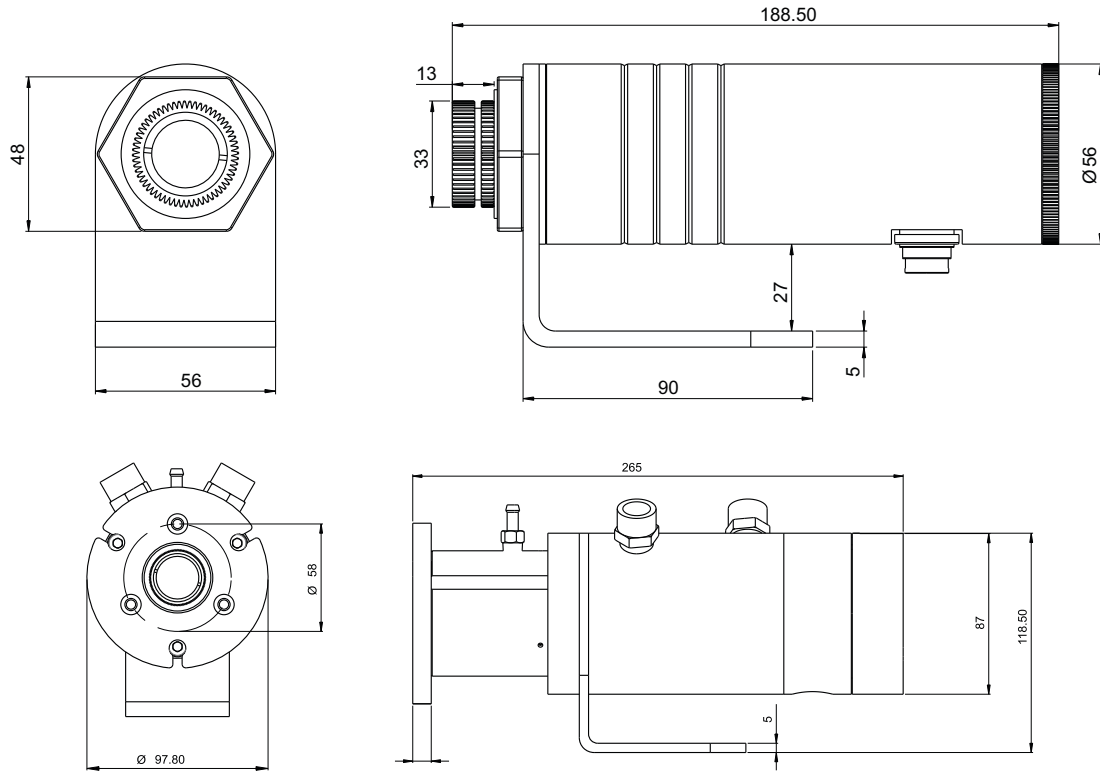

Accessories

<p>Mounting Clamp (Pyrometer) (Reference no: 8500-04)</p>	<p>Air Purge (Reference no: 8500-05)</p>	<p>Mounting Clamp (Water Cooling Jacket) (Reference no: 8500-06)</p>
		
<p>Mounting Flange (Reference no: 8500-07)</p>	<p>Mounting Plate (Reference no: 8500-08)</p>	<p>Water Cooling Jacket (Reference no: 8500-09)</p>
		
<p>Temperature Indicator (Reference no: 9000-01)</p>	<p>Adjustable Mounting Stand (Reference no: 8000-07)</p>	<p>Power supply Input 110/230V AC Reference No. 9000 - 02 Output 24 V DC, 0.7Amp.</p>
		

We measure accurate temperature in extreme conditions

Assembly Options

Pyrometer with Mounting Clamp (8500-04)

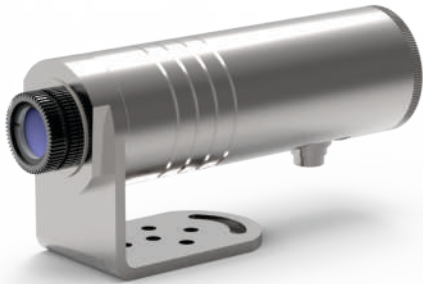

Pyrometer with Mounting Flange (8500-07) + Air Purge (8500-05) + Water Cooling Jacket (8500-09)

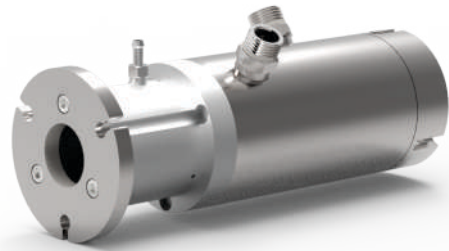

Pyrometer with Air Purge (8500-05) + Mounting Clamp (8500-04)

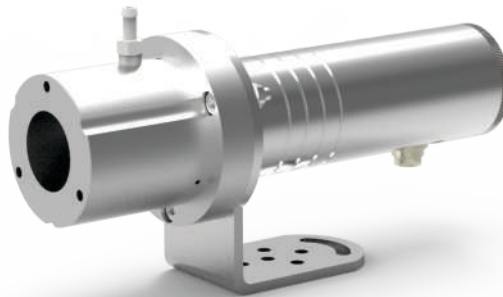

Pyrometer with Mounting Flange (8500-07) + Air Purge (8500-05)

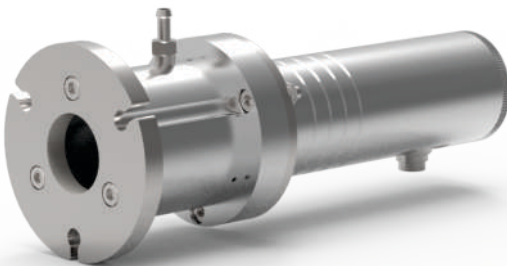

Pyrometer with Mounting Flange (8500-07) + Air Purge (8500-05) + Water Cooling Jacket (8500-09)

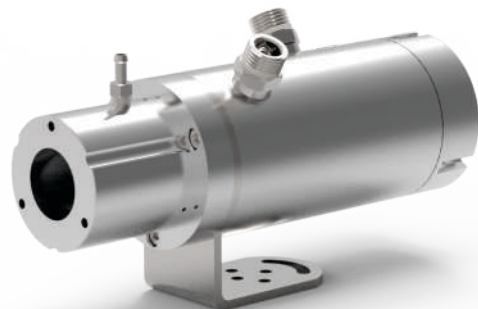

AST 
Accurate Sensors Technologies

Misgav Industrial Park, Misgav 20174 Israel
Ph. : +972-4-9990025, Fax : +972-4-9990031
E-mail : info@accuratesensors.com
www.accuratesensors.com



We measure accurate temperature in extreme conditions